A red square icon is located in the top left corner of the slide, enclosed within a thin red square border. It is positioned at the intersection of a horizontal red line and a vertical red line that runs down the left side of the slide.

# Difference among various products of 38C2 Group

Renesas Technology Corporation  
Renesas LSI Design Corporation  
Renesas Solutions Corporation

## Products effected

- Emulator MCU Standard version, A version  
M38C29RLFS
- Mask ROM version Standard version  
M38C24M4-XXXFP/HP, M38C24M6-XXXFP/HP, M38C29MC-XXXFP/HP
- Flash memory version Standard version  
M38C29FFFP/HP
- Mask ROM version A version  
M38C24M4A-XXXFP/HP, M38C24M6A-XXXFP/HP, M38C29MCA-XXXFP/HP
- Flash memory version A version  
M38C29FFAFP/HP

## Precaution

- When Mask ROM version, Flash memory version and memory size differ in one group, actual values such as an electrical characteristics, operation margin, A-D conversion accuracy, noise immunity, and noise radiation may differ from the ideal values due to the difference in the manufacturing processes.  
When these products are used switching, perform system evaluation for each product of every after confirming product specification.
- This document shows difference, some specifications and standards, not for all.  
Be sure to refer to the most current data sheet as for the latest detailed specification and an electrical characteristics.

# 1.1 Difference among various products of 38C2 Group (1)



	Flash memory version Standard version	Flash memory version A version	Mask ROM version Standard version	Mask ROM version A version
ROM/RAM size[byte]	60K/2K	60K/2K	16K/640, 24K/640, 48K/2K	16K/640, 24K/640, 48K/2K
Oscillation circuit constants	<b>The oscillation circuit constants of X<sub>IN</sub>-X<sub>OUT</sub>, X<sub>CIN</sub>-X<sub>COUT</sub> will depend on each product.</b>			
Input voltage of X <sub>IN</sub> [V]	V <sub>IH</sub> : Min. 1.5 , Max. V <sub>cc</sub> V <sub>IL</sub> : Min. 0 , Max. 0.4	V <sub>IH</sub> : Min. 0.8V <sub>cc</sub> , Max. V <sub>cc</sub> V <sub>IL</sub> : Min. 0 , Max. 0.2V <sub>cc</sub>	V <sub>IH</sub> : Min. 1.5 , Max. V <sub>cc</sub> V <sub>IL</sub> : Min. 0 , Max. 0.4	V <sub>IH</sub> : Min. 0.8V <sub>cc</sub> , Max. V <sub>cc</sub> V <sub>IL</sub> : Min. 0 , Max. 0.2V <sub>cc</sub>
Termination of X <sub>out</sub> pin, using externally generated clock	Pull-up	Open	Pull-up	Open
Sub-clock	External quartz-crystal oscillator or Externally generated clock	External quartz-crystal oscillator	External quartz-crystal oscillator or Externally generated clock	External quartz-crystal oscillator
Absolute maximum ratings Input voltage (CNV <sub>ss</sub> )	-0.3V to 6.5V	←	-0.3V to V <sub>cc</sub> + 0.3V	←
Power source current	See 5.section			
Power supply(V <sub>cc</sub> ) / Main-clock input oscillation frequency	See 6.1. and 6.3.section	See 6.2. and 6.4.section	See 6.1. and 6.3.section	See 6.2. and 6.4.section
Circuit structure of I/O port P35, P36, P55, P56, P57	See 3.section			
The value of internal pull-up resistor (Typ.)	V <sub>cc</sub> = 5V    59kΩ	V <sub>cc</sub> = 5V    42kΩ	V <sub>cc</sub> = 5V    42kΩ	V <sub>cc</sub> = 5V    42kΩ

# 1.2 Difference among various products of 38C2 Group (2)



	Flash memory version Standard version	Flash memory version A version	Mask ROM version Standard version	Mask ROM version A version
Timer X,Y input frequency (Max.) f(CNTR0),f(CNTR1)	2.5<=Vcc<=4.0V : (4 x Vcc - 4)/3 MHz 4.0<=Vcc<=5.5V : 4 MHz	2.5<=Vcc<=4.0V : (Vcc) MHz 4.0<=Vcc<=4.5V : (2 x Vcc - 4) MHz 4.5<=Vcc<=5.5V : 5 MHz	1.8<=Vcc<=2.0V : (5 x Vcc - 8) MHz 2.0<=Vcc<=4.0V : (Vcc) MHz 4.0<=Vcc<=5.5V : 4 MHz	1.8<=Vcc<=2.0V : (5 x Vcc - 8) MHz 2.0<=Vcc<=4.0V : (Vcc) MHz 4.0<=Vcc<=4.5V : (2 x Vcc - 4) MHz 4.5<=Vcc<=5.5V : 5 MHz
Timer X, Timer Y, Timer1, Timer 2, Timer 3 and Timer 4 Clock input frequency (Max.) f(Tclk)	2.5<=Vcc<=4.0V : (8 x Vcc - 8)/3 MHz 4.0<=Vcc<=5.5V : 8 MHz	2.5<=Vcc<=4.0V : (2 x Vcc) MHz 4.0<=Vcc<=4.5V : (4 x Vcc - 8) MHz 4.5<=Vcc<=5.5V : 10 MHz	1.8<=Vcc<=2.0V : (10 x Vcc - 16) MHz 2.0<=Vcc<=4.0V : (2 x Vcc) MHz 4.0<=Vcc<=5.5V : 8 MHz	1.8<=Vcc<=2.0V : (10 x Vcc - 16) MHz 2.0<=Vcc<=4.0V : (2 x Vcc) MHz 4.0<=Vcc<=4.5V : (4 x Vcc - 8) MHz 4.5<=Vcc<=5.5V : 10 MHz
A-D converter (absolute accuracy) 10-bit mode Conditions : VREF=Vcc , f(ADCLK)	5.0V, 4MHz : ± 6LSB 2.5V, 500kHz : ± 5LSB	5.0V, 5MHz : ± 6LSB 4.0V, 4MHz : ± 6LSB 2.5V, 500kHz : ± 5LSB	5.0V, 4MHz : ± 5LSB 2.2V, 500kHz : ± 4LSB	5.0V, 5MHz : ± 5LSB 4.0V, 4MHz : ± 5LSB 2.2V, 500kHz : ± 4LSB
A-D converter (absolute accuracy) 8-bit mode Conditions : VREF=Vcc , f(ADCLK)	5.0V, 4MHz : ± 2LSB 2.5V, 1MHz : ± 2LSB	5.0V, 5MHz : ± 2LSB 4.0V, 4MHz : ± 2LSB 2.5V, 1MHz : ± 2LSB	5.0V, 4MHz : ± 2LSB 2.2V, 1MHz : ± 2LSB	5.0V, 5MHz : ± 2LSB 4.0V, 4MHz : ± 2LSB 2.2V, 1MHz : ± 2LSB



The oscillation circuit constants of XIN-XOUT, XCIN-XCOUT will depend on each product of Mask ROM version (Standard version, A version) and Flash memory version (Standard version, A version).

So that the product used for mass production obtains the stabilized operation clock on the user system and its condition, contact the resonator manufacturer and select the resonator and oscillation circuit constants. Be careful especially when range of voltage and temperature is wide.

We recommend to design the circuit in consideration of the wiring pattern of the feed-back resistor, the dumping resistor and the load capacity in advance.

We publish the reference-use oscillation circuit parameters in Renesas Technology home page.

<http://www.renesas.com/en/38000>

### 3. Circuit structure of I/O port

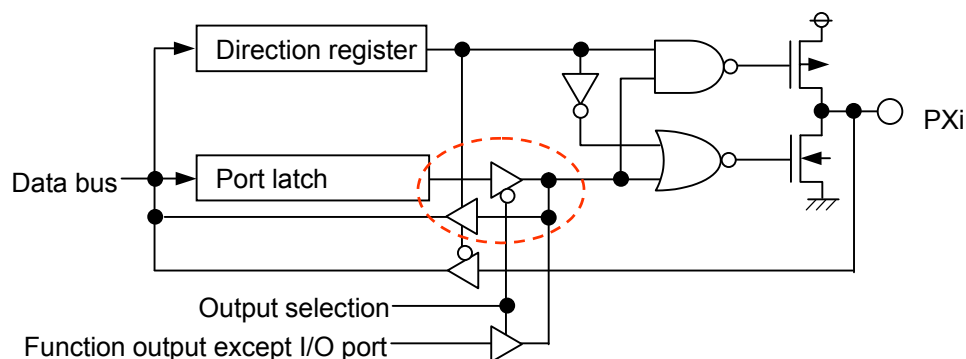

**Type A**

Type A : If data is read from a pin set to output, the value of the function output except I/O port is read.  
 Type B : If data is read from a pin set to output, the value of the port latch is read.

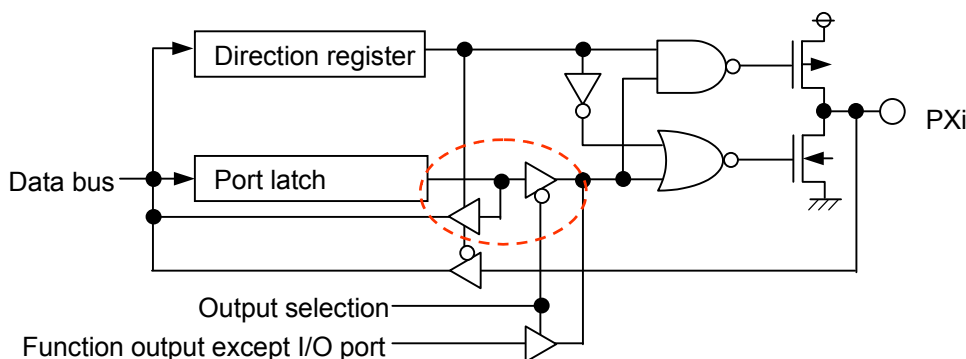

**Type B**

	Standard version	A version
P35/TXOUT	Type B	Type A
P36/T2OUT	Type B	Type A
P55/TxD1	Type A	Type B
P56/SCLK1	Type A	Type B
P57/SRDY1	Type A	Type B

## 4. Difference of Emulator MCU



	Emulator MCU Standard version	Emulator MCU A version
Oscillation circuit constants	<b>The oscillation circuit constants of XIN-XOUT, XCIN-XCOUT will depend on each product.</b>	
Input voltage of XIN [V]	V <sub>IH</sub> : Min. 1.5, Max.V <sub>cc</sub> V <sub>IL</sub> : Min. 0, Max. 0.4	V <sub>IH</sub> : Min. 0.8V <sub>cc</sub> , Max. V <sub>cc</sub> V <sub>IL</sub> : Min. 0, Max. 0.2V <sub>cc</sub>
Termination of Xout pin, using externally generated clock	Pull-up	Open
Sub-clock	External quartz-crystal oscillator or Externally generated clock	External quartz-crystal oscillator
Power supply(V <sub>cc</sub> ) / Main-clock input oscillation frequency	See MASK ROM version of 6.1. and 6.3.section	See MASK ROM version of 6.2. and 6.4. section
Circuit dtructure of I/O port P35, P36, P55, P56, P57	See 3.section	
Value of internal pull-up register (Typ.)	V <sub>cc</sub> = 5V    59kΩ	V <sub>cc</sub> = 5V    42kΩ
Timer X,Y input frequency (Max.) f(CNTR0),f(CNTR1)	1.8<=V <sub>cc</sub> <=4.0V : (4 x V <sub>cc</sub> - 4)/3 MHz 4.0<=V <sub>cc</sub> <=5.5V : 4 MHz	1.8<=V <sub>cc</sub> <=4.0V : (V <sub>cc</sub> ) MHz 4.0<=V <sub>cc</sub> <=4.5V : (2 x V <sub>cc</sub> - 4) MHz 4.5<=V <sub>cc</sub> <=5.5V : 5 MHz
Timer X,Timer Y,Timer1,Timer 2,Timer 3 and Timer 4 Clock input frequency (Max.) f(Tclk)	1.8<=V <sub>cc</sub> <=4.0V : (8 x V <sub>cc</sub> - 8)/3 MHz 4.0<=V <sub>cc</sub> <=5.5V : 8 MHz	1.8<=V <sub>cc</sub> <=4.0V : (2 x V <sub>cc</sub> ) MHz 4.0<=V <sub>cc</sub> <=4.5V : (4 x V <sub>cc</sub> - 8) MHz 4.5<=V <sub>cc</sub> <=5.5V : 10 MHz

### How to discriminate between standard version and A version?

In Emulator MCU M38C29RLFS, standard version's name and A version's name are the same. It is possible to discriminate with the prefix of product number.

Standard version : 0XXXXXX, 1XXXXXX, 2XXXXXX

A version : except the above number

# 5. Electrical characteristics (Power source current)

Symbol	Parameter	Test conditions	Flash memory version Standard version		Flash memory version A version		Mask ROM version Standard version		Mask ROM version A version		Unit
			Typ.	Max.	Typ.	Max.	Typ.	Max.	Typ.	Max.	
I <sub>cc</sub>	Power source current	Frequency/2 mode, V <sub>cc</sub> = 5V, f(XIN) = 10MHz, f(XCIN) = 32.768kHz Output transistors "off", A-D converter in operating	-	-	6.0	8.6	-	-	3.4	5.1	mA
		Frequency/2 mode, V <sub>cc</sub> = 5V, f(XIN) = 8MHz, f(XCIN) = 32.768 kHz Output transistors "off", A-D converter in operating	5.0	7.2	5.0	7.2	2.7	4.2	2.7	4.2	mA
		Frequency/2 mode, V <sub>cc</sub> = 5V, f(XIN) = 8MHz (in WIT state), f(XCIN) = 32.768kHz, Output transistors "off", A-D converter stop	1.0	2.0	1.0	2.0	1.0	2.0	1.0	2.0	mA
		Low-speed mode, V <sub>cc</sub> = 5V, T <sub>a</sub> ≤ 55°C, f(XIN) = stopped f(XCIN) = 32.768kHz, Output transistors "off"	150	200	150	200	14	21	14	21	μA
		Low-speed mode, V <sub>cc</sub> = 5V, T <sub>a</sub> =25°C, f(XIN) = stopped f(XCIN) = 32.768kHz(in WIT state), Output transistors "off"	6	10	6	10	6	10	6	10	μA
		Low-speed mode, V <sub>cc</sub> = 3V, T <sub>a</sub> ≤ 55°C, f(XIN) = stopped f(XCIN) = 32.768kHz, Output transistors "off"	125	165	125	165	7	12	8	13	μA
		Low-speed mode, V <sub>cc</sub> = 3V, T <sub>a</sub> =25°C, f(XIN) = stopped f(XCIN) = 32.768kHz(in WIT state), Output transistors "off"	3	6	4	8	3	6	4	8	μA
		All oscillation stopped (in STP state), T <sub>a</sub> =25°C, Output transistors "off"	0.1	1.0	0.1	1.0	0.1	1.0	0.1	1.0	μA
		All oscillation stopped (in STP state), T <sub>a</sub> =85°C, Output transistors "off"	-	10	-	10	-	10	-	10	μA



# 6.1. Internal-clock vs. Vcc (Except A-D converter)

## Standard version

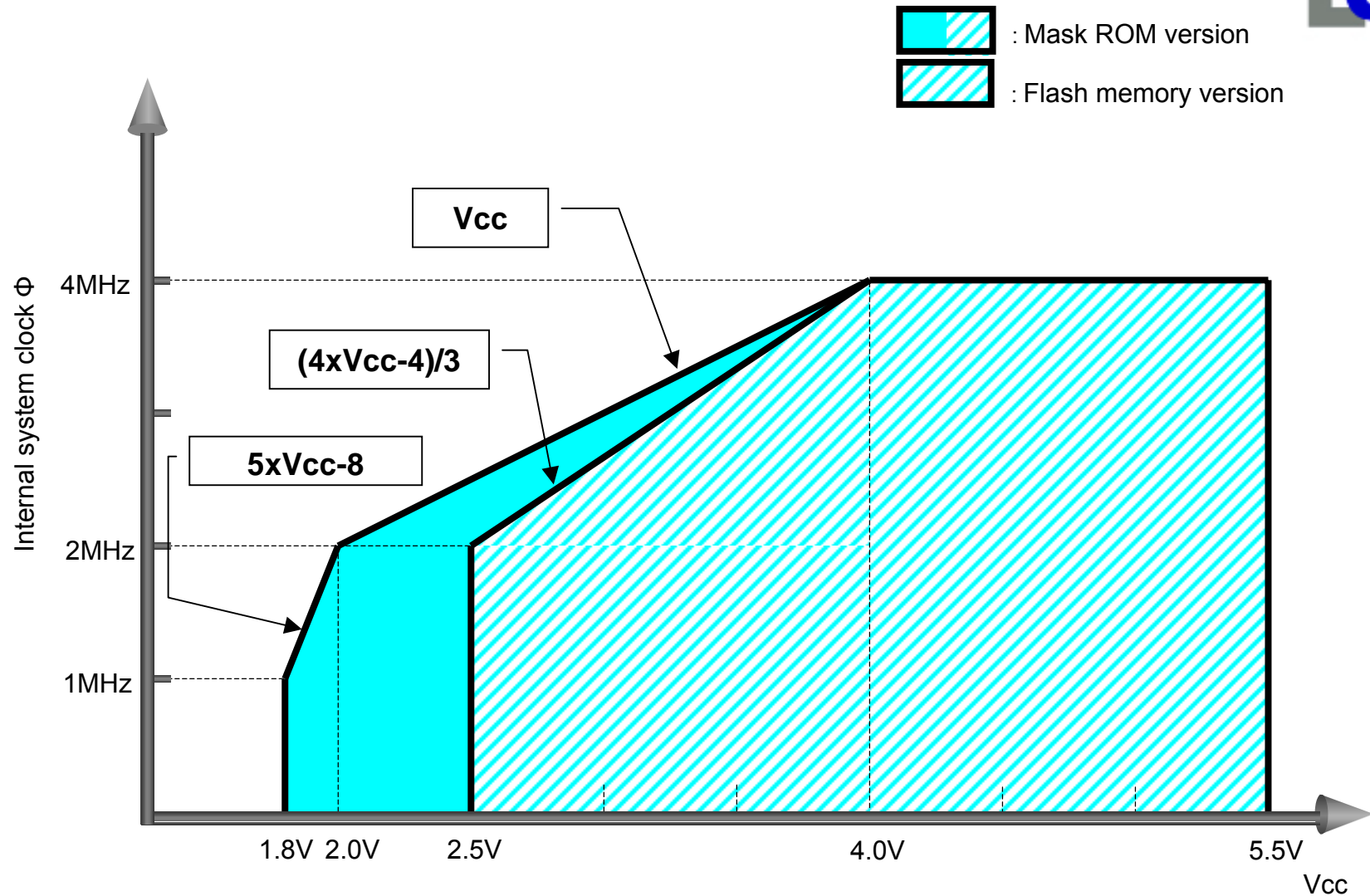

## 6.2. External-clock vs. Vcc (Except A-D converter)



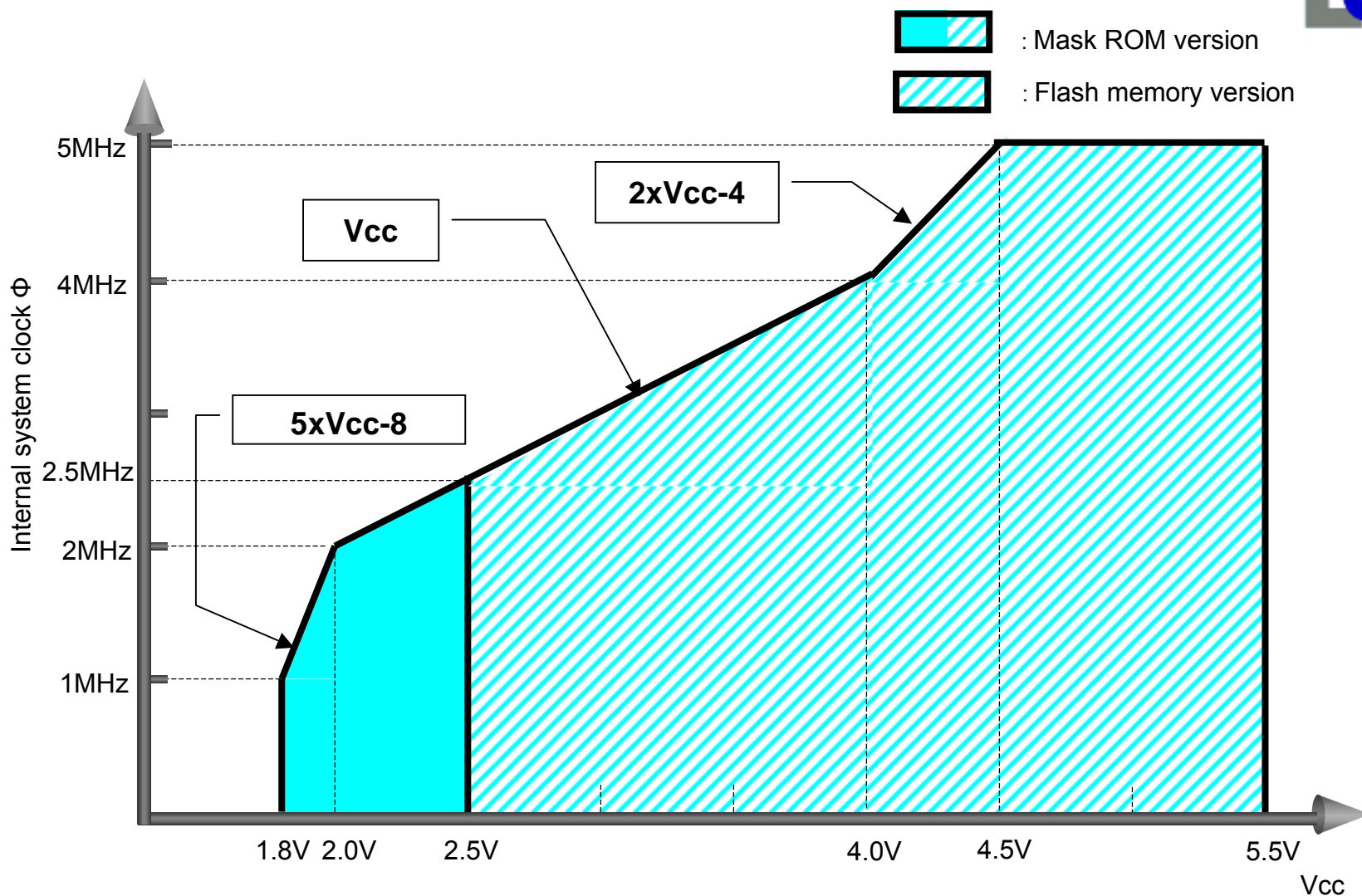

### A version



# 6.3. External-clock vs. Vcc (A-D converter in operating)

## Standard version



-  : Mask ROM version (8-bit A-D mode)
-  : Flash memory version (8-bit A-D mode)
-  : Mask ROM version (10-bit A-D mode)
-  : Flash memory version (10-bit A-D mode)

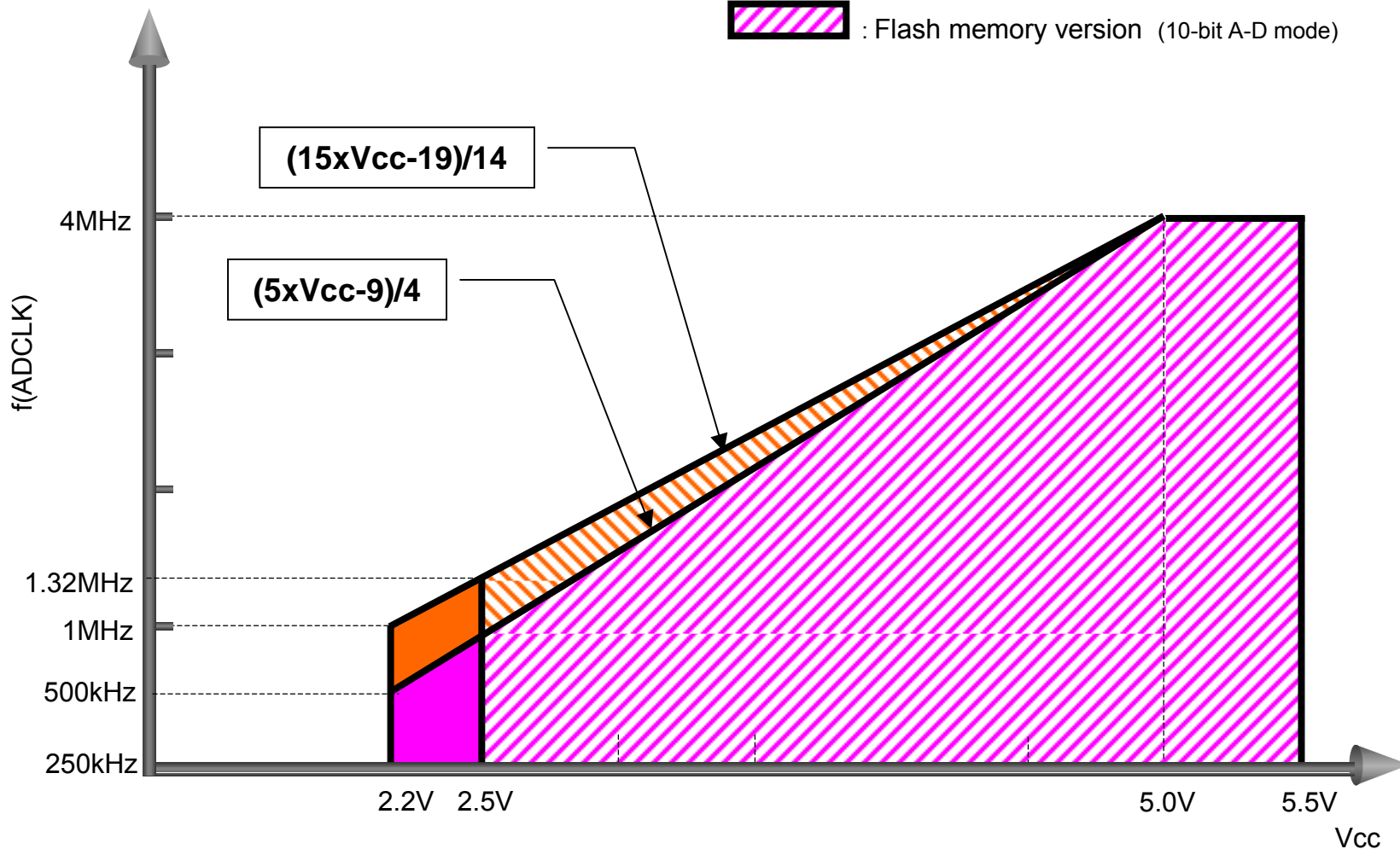





Note :  $f(ADCLK)=f(XIN)/2, f(XIN)/4, f(XIN)/8, f(XIN)/16$

# 6.4. External-clock vs. Vcc (A-D converter in operating)

A version



-  : Mask ROM version (8-bit A-D mode)
-  : Flash memory version (8-bit A-D mode)
-  : Mask ROM version (10-bit A-D mode)
-  : Flash memory version (10-bit A-D mode)

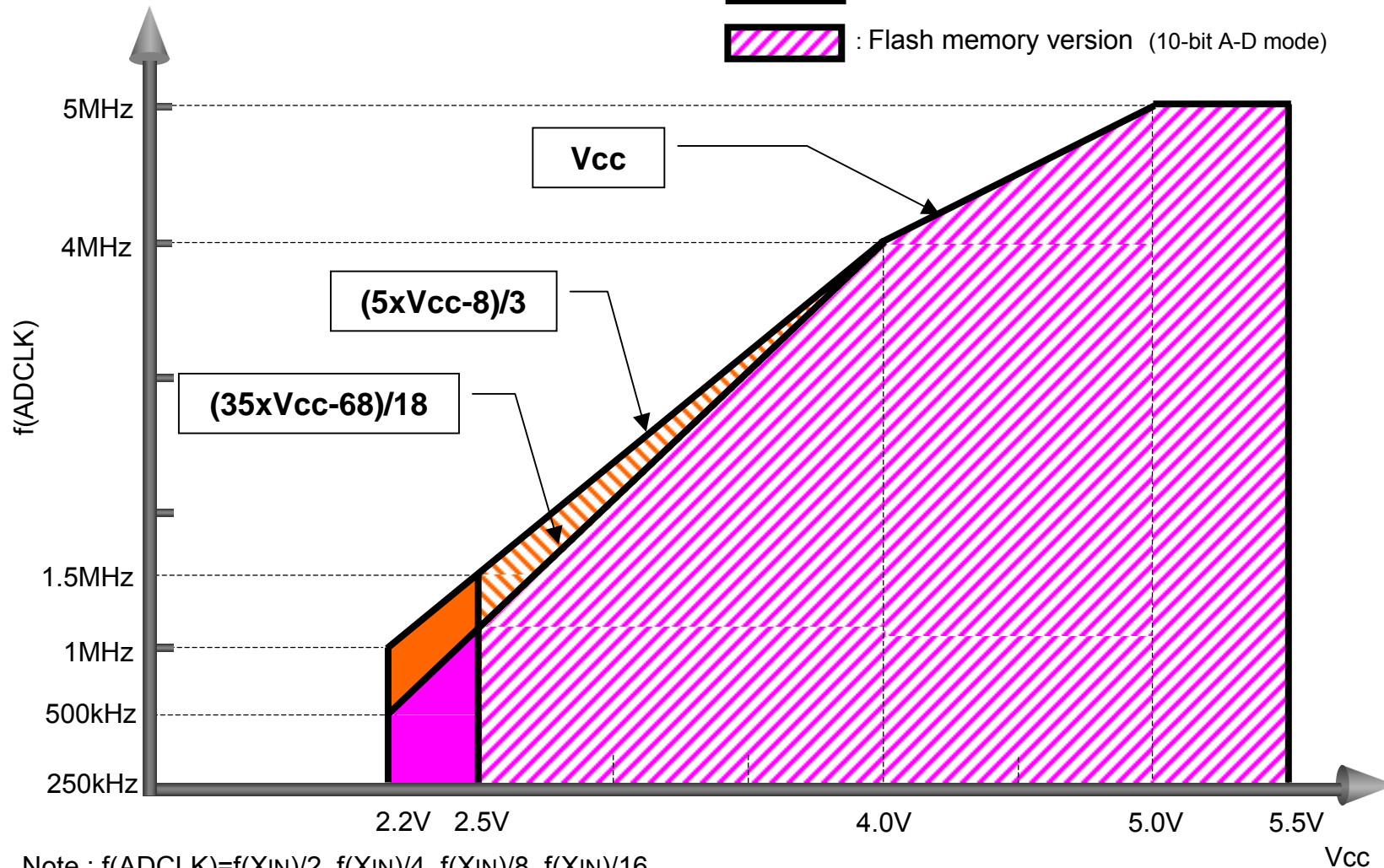

Note :  $f(ADCLK) = f(XIN)/2, f(XIN)/4, f(XIN)/8, f(XIN)/16$